



McAllister®

Under-Mount Kitchen Sink

11409-L

Features

- Under-mount
- No faucet holes to accommodate either wall-mount or countertop faucets
- 8-5/16"-deep double bowls
- 3-3/4" drain opening
- Stainless steel with luster finish
- SilentShield technology
- 18-gauge stainless steel
- Lifetime limited warranty

Recommended Products/Accessories

- 7400 Sink Strainer
- 11862 Sink Rack
- 11863 Sink Rack
- K-6139 Sponge Caddy

Included Components

- Product consists of:
- 91915 Hardware Kit

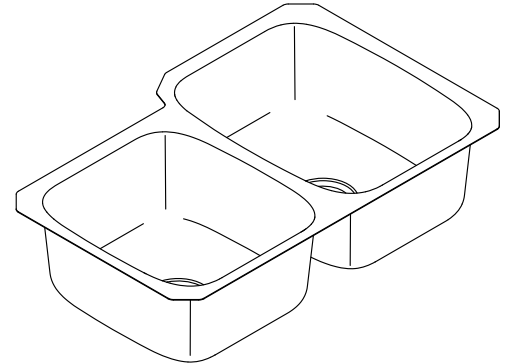

Codes/Standards

ASME A112.19.3/CSA B45.4

STERLING® Warranty - Stainless Steel Sinks

See website for detailed warranty information.

Mounting bracket assembly provides a secure installation.

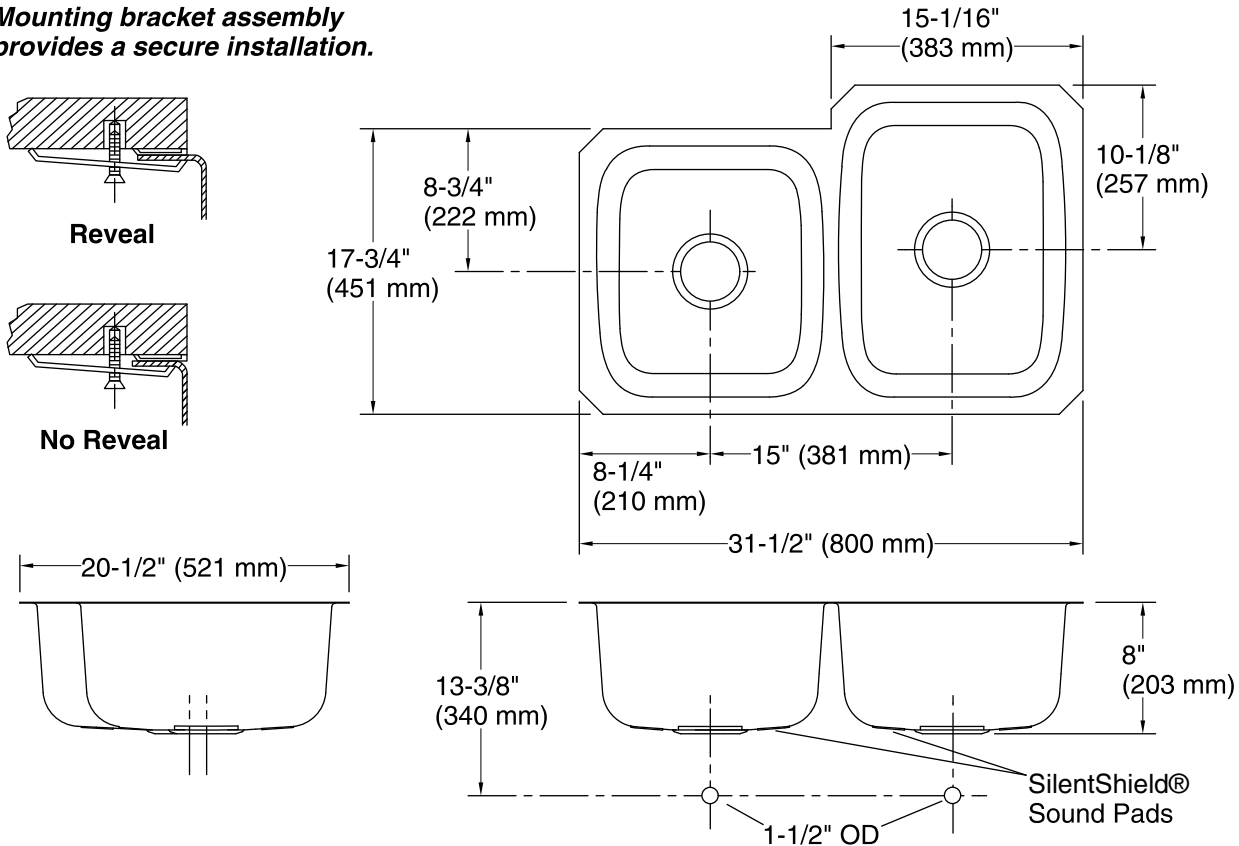

Technical Information

All product dimensions are nominal.

- Bowl configuration: Off-set Large/small
- Installation: Under-mount
- Bowl area (Left): Length: 14-1/4" (362 mm)
Width: 15-3/4" (400 mm)
Bowl depth: 8" (203 mm)
Water depth: 8" (203 mm)
- Bowl area (Right): Length: 14-1/4" (362 mm)
Width: 18-1/2" (470 mm)
Bowl depth: 8" (203 mm)
Water depth: 8" (203 mm)
- Drain hole: 3-3/4" (95 mm)
- Template: 1315848-7, required, included

Notes

- Install this product according to the installation instructions.
- Measure your actual product for roughing-in details.
- Use the supplied cut-out template to select either a hidden or exposed rim.