

INSTALLATION INSTRUCTIONS FOR 5136

**WARNING! SHUT POWER OFF AT FUSE OR CIRCUIT BREAKER .
AVERTISSEMENT! COUPER LE COURANT AU NIVEAU DES FUSIBLES OU DU DISJONCTEUR.**

READ AND SAVE THESE INSTRUCTIONS

PREPARATION (Fig. 1)

1. Shut off the power at the fuse box or circuit breaker. If necessary, remove the old fixture including the mounting hardware.
2. Carefully remove the new fixture from the carton and check that all parts are included as shown in the illustration.

MOUNTING THE FIXTURE (Fig.1)

3. Position the mounting bracket (B) on the wall, and mark the location of the two dry wall anchors (A). Pre-drill the holes for the drywall anchors (A) and insert the drywall anchors (A) into the wall.
4. Attach the mounting bracket (B) to the junction box using the junction box screws (D) (Size: #8-32*0.6"L). The side of the mounting bracket marked "GND" must face out.
5. Place the wood screws (C) through the mounting bracket (B) and into the drywall anchors (A) to secure the mounting bracket (B) to the wall.

CONNECTING THE WIRES (Fig. 2)

6. At this point, connect the electrical wires as shown in Fig. 2, making sure that all wire connectors are secured. If your outlet box has a ground wire (green or bare copper), connect the fixture's ground wire to it. Otherwise, connect the fixture's ground wire directly to the mounting plate using the green screw provided. After the wires are connected, tuck them carefully inside the outlet box.

COMPLETING THE INSTALLATION (Fig. 1)

7. Place the fixture body (F) over the mounting bracket (B), and secure with mounting screws (E) (Size:#8-32*0.5"L).
8. Install the light bulbs (included) in accordance with the fixture's specifications (**DO NOT EXCEED THE MAXIMUM WATTAGE!**) (**NE PAS DEPASSER LA PUISSANCE NOMINALE MAXIMALE!**)

Your installation is now complete. Return the power to the junction box and test the fixture.

Note: Illustration (Fig.1) on this manual is for installation purposes only. It may or may not be identical to the fixture purchased.

Fig.1

- Set# A-021-190104
- Hanging bracket
 - Ground screw
 - Mounting screws*4
 - Junction box screws*2
 - Wood screws*2
 - Anchors*2

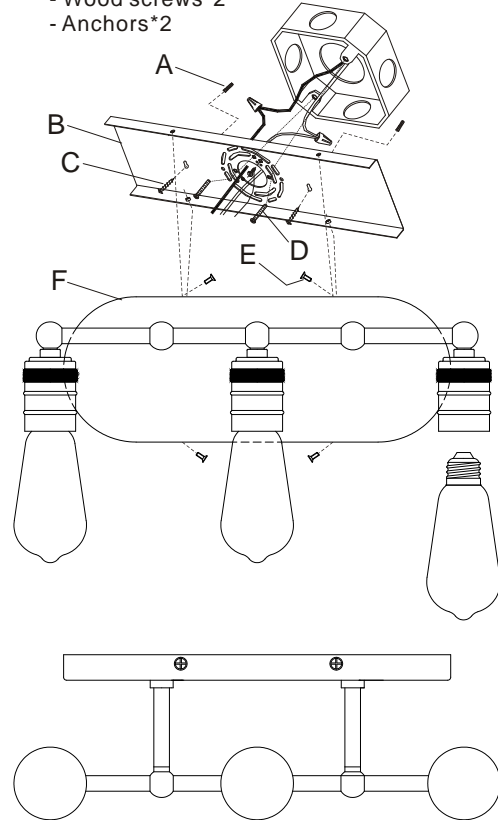

Fig.2

