

ARC MARFS-656GPSB



*Flush-Mount Installation Kit is included with each sink
 *Custom ADA compliant versions are available

FEATURES

- 16-gauge type 304 stainless steel
- Solid brass under rim support
- 1/4" round profile basin

TECHNICAL INFORMATION

- External dimension: 32.5" L x 18" W x 10"D
- Basin dimensions: 31" L x 16.5" W x 10"D
- Frame width: 3/4" • Frame thickness: 5/16"

FINISHES

- Graphite PVD Satin Brushed stainless steel

INSTALLATION OPTIONS

- Flush-mount • Drop-in

MINIMUM CABINET SIZE (I.D.)

- Flush-mount 33.5"

INDUSTRY'S ONLY STAINLESS STEEL SINK DESIGNED SPECIFICALLY TO BE FLUSH-MOUNTED

INTERNATIONAL PATENT PENDING

INSTALLATION TYPE

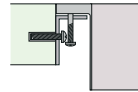

Flush-mount



Included MTK-613SS
Flush Mount Kit

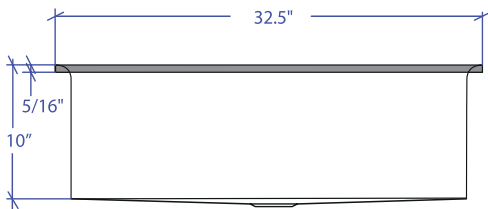
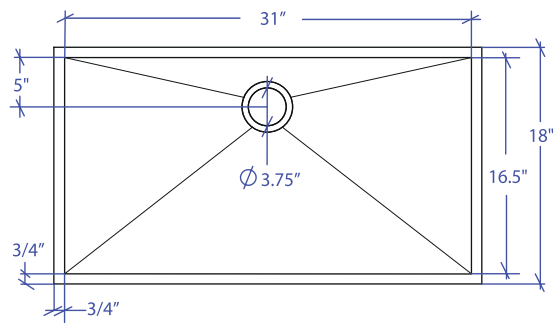

OPTIONAL ACCESSORIES

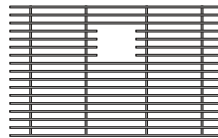

MBG-656GPSB
Basin Grid

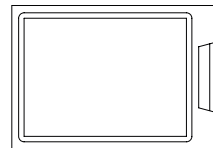

MCB-651BB
Cutting Board

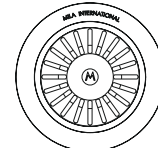

MKD-101GPSB
Strainer

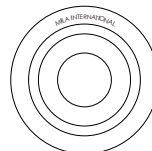

MDC-101GPSB
Disposal Collar

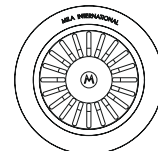

MDC-102GPSB
Disposal Collar

PROJECT INFORMATION			
Project			
Date	/ /	QTY	
Specifier			
Contact			
Note			