

# FLATIRON MUS-656SB



\*Custom ADA compliant versions are available

## • FEATURES

- 16-gauge type 304 stainless steel
- 90° zero radius design

## • TECHNICAL INFORMATION

- External dimension: 34"Lx18.5"Wx10"D
- Basin dimensions: 32"Lx16.5"Wx10"D

## • FINISHES

- Satin Brushed stainless steel

## • INSTALLATION OPTIONS

- Top-mount
- Under-mount

## • MINIMUM CABINET SIZE (I.D.)

- Top-mount 35"
- Under-mount 37"

## • DUAL-MOUNT INSTALLATION

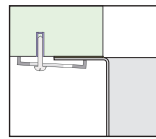

Under-mount

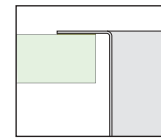

Top-mount

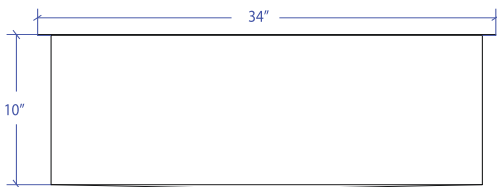
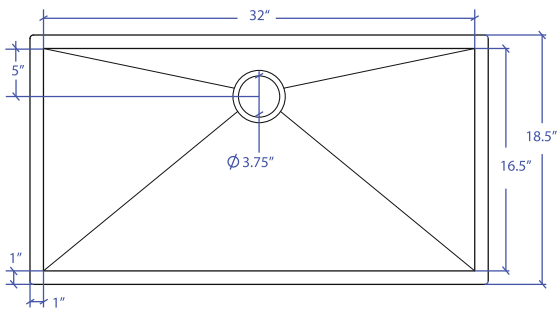

## • ACCESSORY OPTIONS

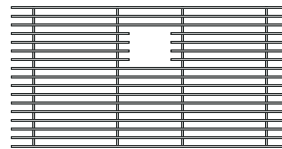

MBG-6513SB  
Basin Grid

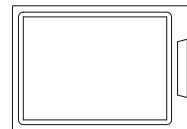

MCB-651BB  
Cutting Board

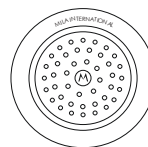

MKD-101SB  
Strainer

PROJECT INFORMATION			
Project			
Date	/ /	QTY	
Specifier			
Contact			
Note			