

ATELIER MTD-803SB

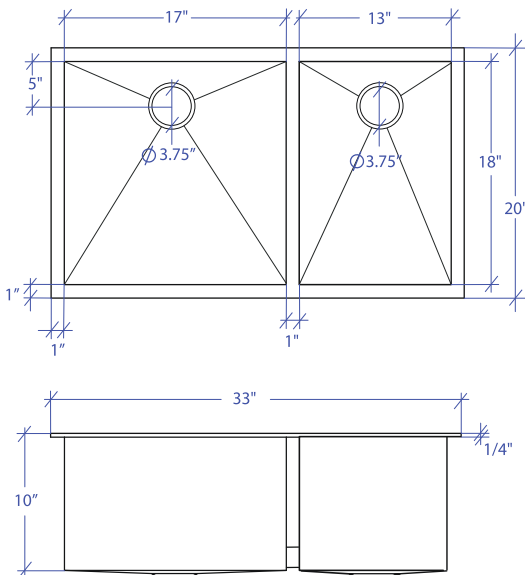

*Custom ADA compliant sinks are available



• FEATURES

16-gauge type 304 stainless steel
TRI-MOUNT™ installation system

• TECHNICAL INFORMATION

External dimension: 33"L x 20"W x 10"D
Basin dimensions:
Left: 17"L x 18"W x 10"D
Right: 13"L x 18"W x 10"D
Frame width: 1"
Frame thickness: 1/4"

• FINISHES

Satin Brushed stainless steel

• INSTALLATION OPTIONS

Flush-mount
Top-mount
Under-mount

• MINIMUM CABINET SIZE (I.D.)

Flush-mount 36"
Top-mount 33"
Under-mount 37"

• INDUSTRY'S ONLY STAINLESS STEEL SINK DESIGNED SPECIFICALLY TO BE FLUSH-MOUNTED

• U.S. PATENT NO. 9,988,799

• CANADIAN PATENT NO. 2579506

• TRI-MOUNT INSTALLATION

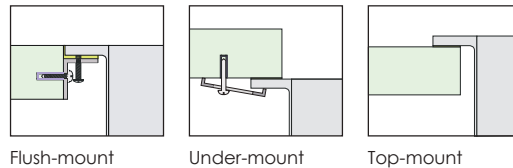

• ACCESSORIES

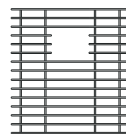

MBG-083SB
Basin Grid

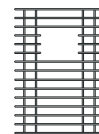

MBG-082SB
Basin Grid

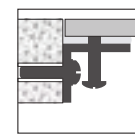

MTK-112AL
Mounting Kit

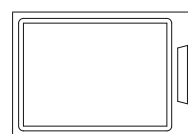

MCB-801BB
Cutting Board



MKD-101SB
Strainer

PROJECT INFORMATION			
Project			
Date	/ /	QTY	
Specifier			
Contact			
Note			