

ORION MOUS-654GPSB



*Custom ADA compliant versions are available

• FEATURES

16-gauge type 304 stainless steel
Bevel basin design

• TECHNICAL INFORMATION

External dimension: 28"Lx18.5"Wx10"D
Basin dimensions: 26"Lx16.5"Wx10"D

• FINISHES

Graphite PVD Satin Brushed stainless steel

• INSTALLATION OPTIONS

Top-mount
Under-mount

• MINIMUM CABINET SIZE (I.D.)

Top-mount 29"
Under-mount 31"

• US DESIGN PATENT D618,324 S

• DUAL-MOUNT INSTALLATION

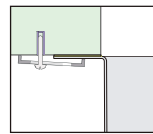

Under-mount

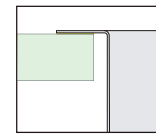

Top-mount

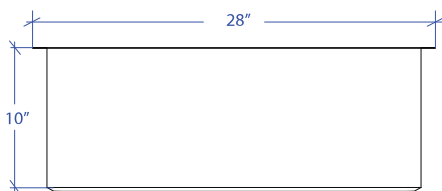
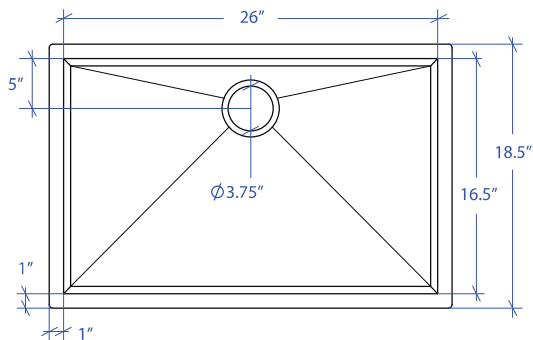

• ACCESSORY OPTIONS

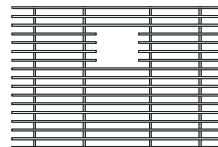

MBG-6510GPSB
Basin Grid

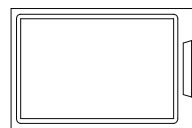

MCB-651BB
Cutting Board

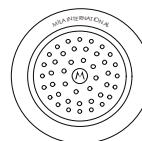

MKD-101GPSB
Strainer

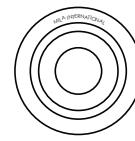

MDC-101GPSB
Disposal Collar

PROJECT INFORMATION

Project			
Date	/	/	QTY
Specifier			
Contact			
Note			