

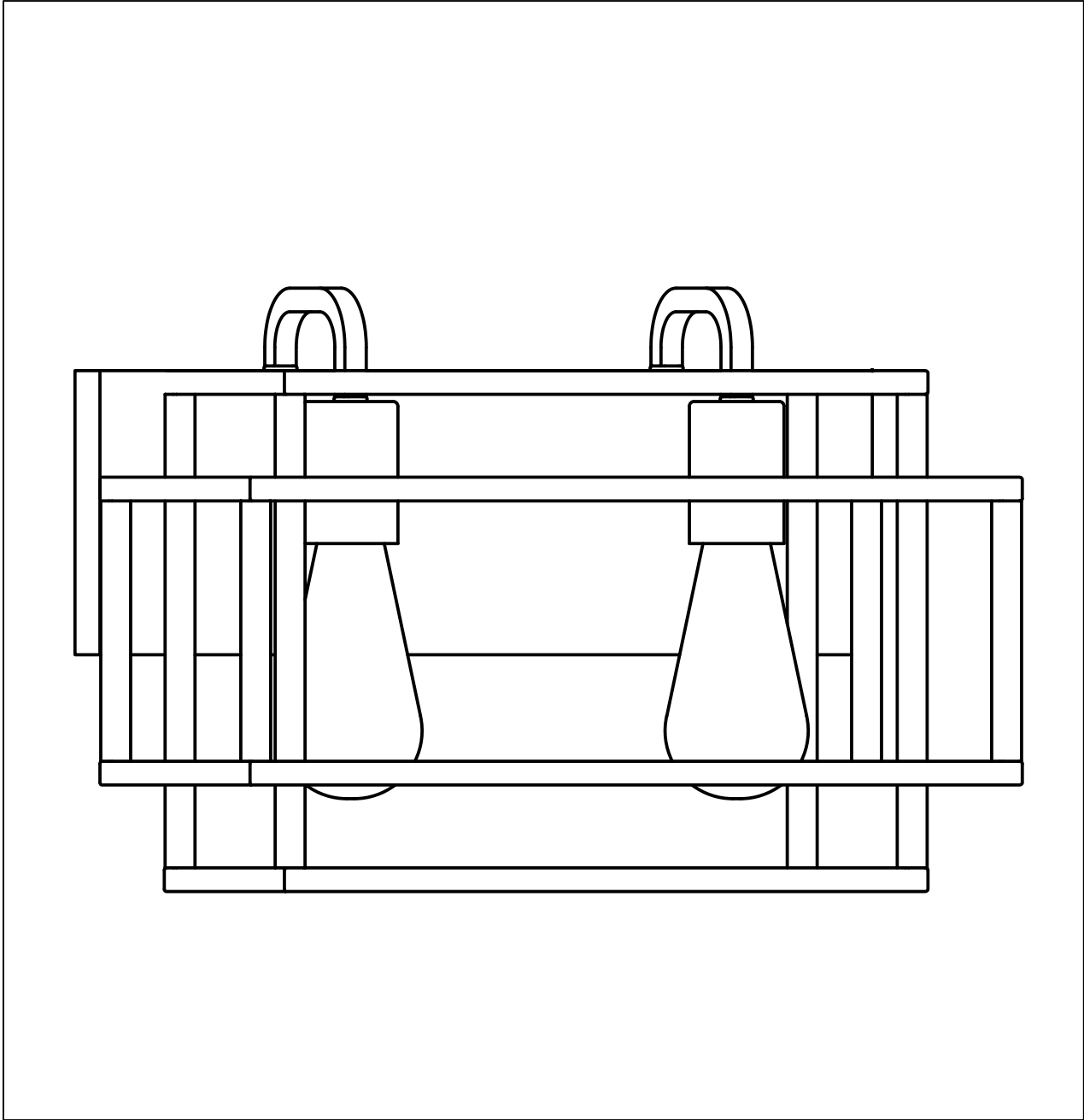

PRODUCT NAME: Liner 2-Light Wall Sconce  
ITEM NUMBER: 10242



Bulbs (Not Included) : E26 2\*60W ST64

**IMPORTANT:** Turn off the power at the main fuse or circuit breaker box before starting installation

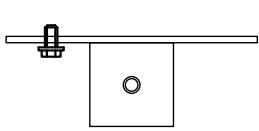

Bracket(A)



(B)



(C)

Mounting Screws



Canopy(D)



Bulb(E)

Locate all hardware & components before discarding packaging

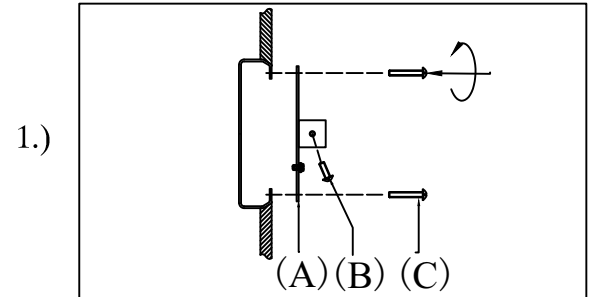
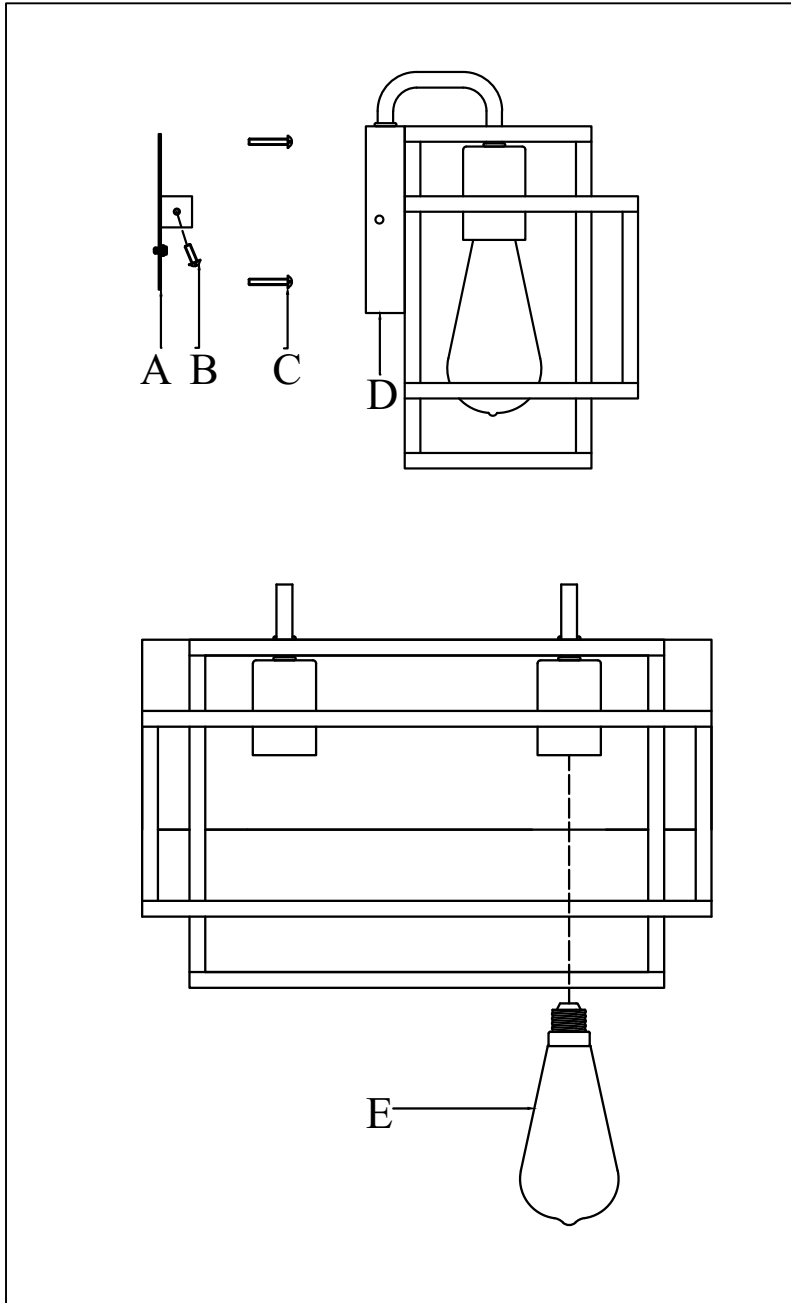

1.)

Step1 :Remove mounting bracket from fixture and install to electrical box.

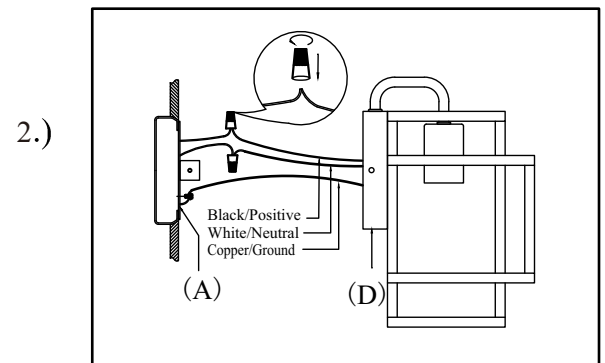

2.)

Step2 :Wire fixture to wires in outlet box.Copper wire is for Ground.

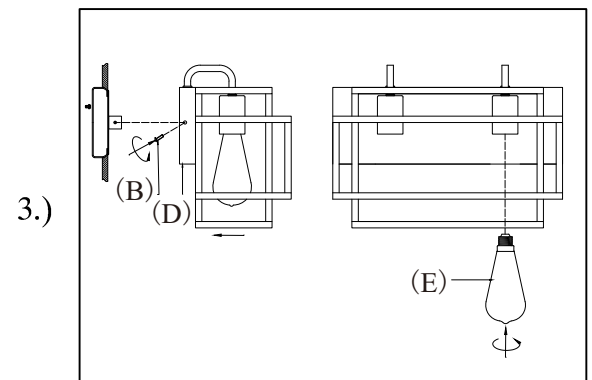

3.)

Step3 : Install lamp body to back plate using two screws on side. Install bulb into socket.

**Cleaning & Care:**

Clean with soft cloth and a mild detergent.  
Do not use abrasive cleaner.