

KOHLER® Faucets

Widespread wall-mount bathroom sink faucet trim with cross handles, 1.2 gpm K-T14413-3

Purist®

Features

- Dual-control wall-mounted
- Cross handles
- Stationary spout
- Less drain
- 6-3/4" (171 mm) Max 35° spout from wall to center of drain
- 1.2 gpm (4.5 lpm) maximum flow rate at 60 psi (4.14 bar)

Material

- Brass
- KOHLER finishes resist corrosion and tarnishing

Required Products/Accessories

K-410-K Wall-mount Valve

Recommended Products/Accessories

K-23726 Drain treatment
 K-23723 Faucet cleaner
 K-14375 24" Double Towel Bar
 K-14377 Pivoting toilet paper holder
 K-14435 18" Towel Bar
 K-14436 24" Towel Bar
 K-14441 Towel Ring
 K-14443 Robe Hook
 K-14444 Vertical toilet paper holder

Optional Products/Accessories

K-7107 Decorative Drain
 K-7108 Decorative Drain
 K-7114 Pop-Up Drain
 K-7124 Pop-Up Clicker Drain
 K-7129 Drain
 K-7127 Drain



ADA



Codes/Standards







ASME A112.18.1/CSA B125.1
 NSF/ANSI/CAN 61
 NSF/ANSI/CAN 372
 All applicable US Federal and State material regulations
 DOE - Energy Policy Act 1992
 EPA WaterSense®
 California Energy Commission (CEC)
 ADA
 ICC/ANSI A117.1

KOHLER® Faucet Lifetime Limited Warranty

See website for detailed warranty information.

Available Colors/Finishes

Color tiles intended for reference only.

Color	Code	Description
	CP	Polished Chrome
	SN	Vibrant® Polished Nickel
	AF	Vibrant® French Gold
	BN	Vibrant® Brushed Nickel
	BV	Vibrant® Brushed Bronze
	BL	Matte Black
	AMP	Vibrant® Brushed Moderne

1-800-4KOHLER (1-800-456-4537)

Kohler Co. reserves the right to make revisions without notice to product specifications.

For the most current Specification Sheet, go to www.kohler.com.

2-9-2023 09:45 - US/CA

THE BOLD LOOK
OF **KOHLER®**

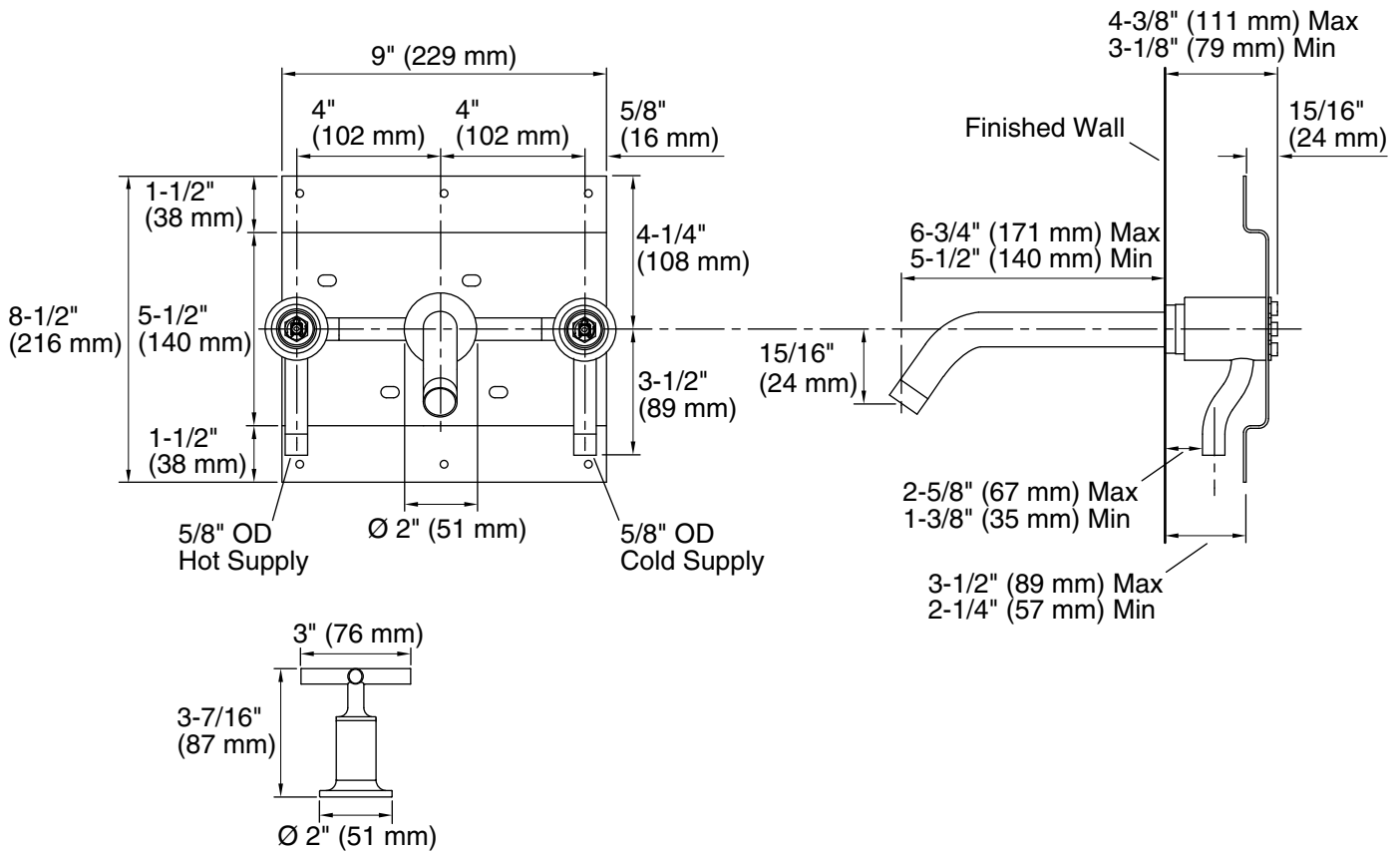

Technical Information

All product dimensions are nominal.

Faucet:

Flow rate: 1.2 gal/min (4.5 l/min)

Pressure: 60 psi (4.1 bar)

Spout:

Spout reach: 6-3/4" (171 mm)

Notes

Install this product according to the installation guide.

The distance between the bottom of spout and top of the fixture rim must not be less than 1-1/2" (38 mm) and not greater than 6" (152 mm).

Three 1-1/2" (38 mm) diameter cutout holes are required for spout and handles.

ADA compliant for handles only.

ADA compliant when installed to the specific requirements of these regulations.