



Underscore® Rectangle

5.5' Bath
K-1136-W1

Features

- Bask® heated surface creates spa-like relaxation with soothing warmth on your back and neck.
- Customize the heat with three adjustable settings.
- Molded lumbar support offers extra comfort while bathing.
- Slotted overflow allows for deep soaking.
- End drain.
- Under-mountable

Material

- Acrylic

Installation

- Drop-in or under-mount.
- Requires 110V electrical service.

Additional Hydrotherapy Options

- Soaking Bath - 1136-0
- Soaking Bath + Bask heated surface - 1136-W1
- BubbleMassage air bath - 1173-G
- BubbleMassage air bath + chromatherapy - 1173-GCR
- VibrAcoustic + BubbleMassage air bath - 1173-GVB
- VibrAcoustic + BubbleMassage air bath + Bask heated surface + chromatherapy - 1173-GVBCW
- Whirlpool + heater - 1173-H2
- VibrAcoustic - 1173-VB
- VibrAcoustic + chromatherapy - 1173-VBC
- VibrAcoustic + chromatherapy + Bask heated surface - 1173-VBCW
- VibrAcoustic + Bask heated surface - 1173-VBW
- Whirlpool + BubbleMassage air bath - 1173-XH2G

Required Products/Accessories

K-7271 Brass Slotted Overflow Bath Drain

or

K-7272 PVC Slotted Overflow Bath Drain

Recommended Products/Accessories

K-591 Under-Mount Installation Kit

K-24916 Wireless Music Kit

K-1177 Vinyl Tiling-in Bead



Codes/Standards

CSA B45.5/IAPMO Z124

ASTM E162

ASTM E662

UL 1795

CSA C22.2 No. 218.2

KOHLER® Plastic Baths and Receptors

Lifetime Limited Warranty









KOHLER® Hydrotherapy Components

Five-Year Limited Warranty

See website for detailed warranty information.

Available Colors/Finishes

Color tiles intended for reference only.

Color	Code	Description
	0	White
	96	Biscuit
	47	Almond
	NY	Dune
	95	Ice™ Grey
	G9	Sandbar
	K4	Cashmere
	58	Thunder™ Grey
	7	Black Black™

1-800-4KOHLER (1-800-456-4537)

Kohler Co. reserves the right to make revisions without notice to product specifications.

For the most current Specification Sheet, go to www.kohler.com.

9-7-2019 05:35 - US/CA

THE BOLD LOOK
OF **KOHLER**®

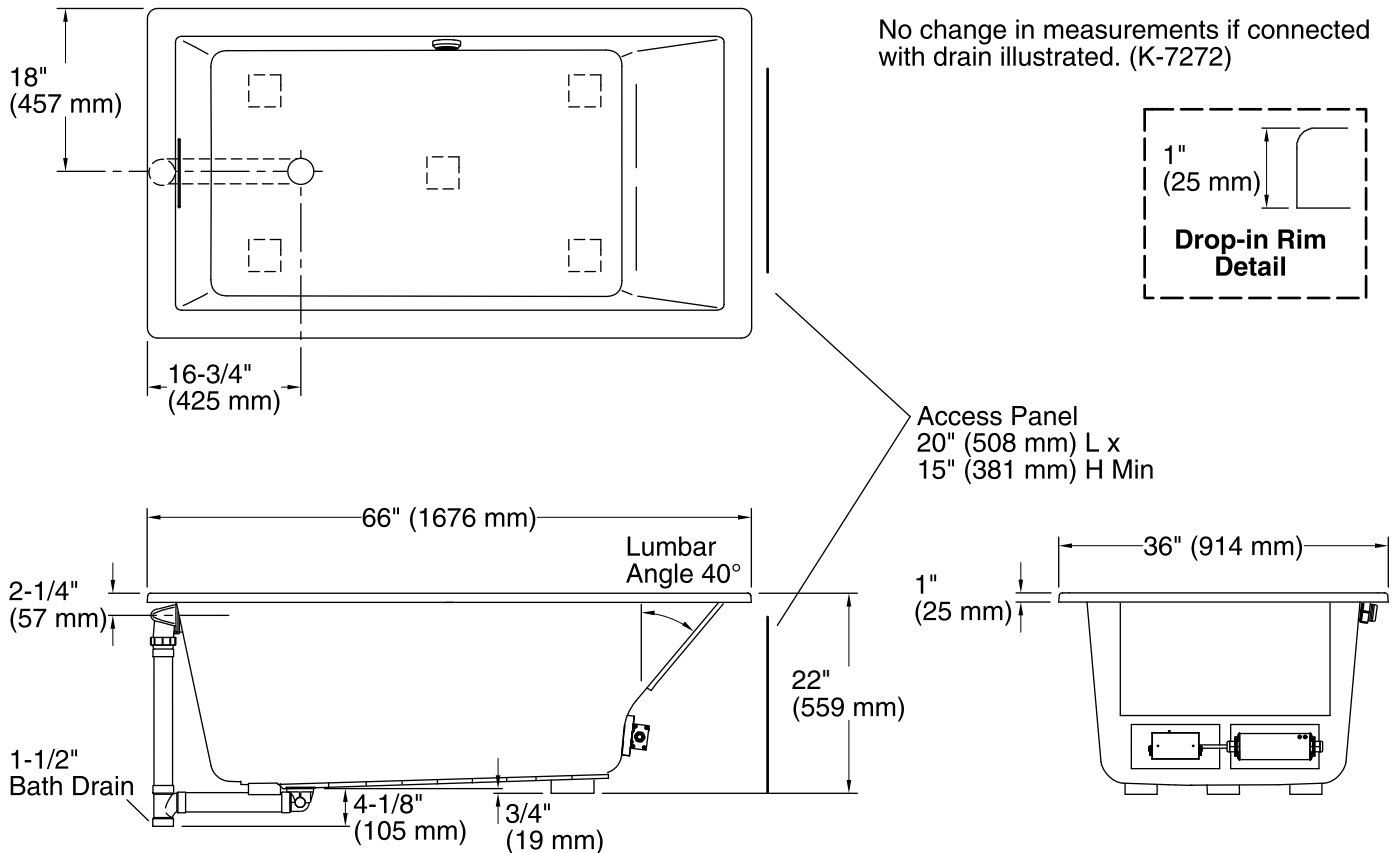

Required Electrical Service

One circuit required, protected with Class A Ground-Fault Circuit-Interrupter (GFCI). Outside North America, this device may be known as a Residual Current Device (RCD).

Heated Surface: 120 V, 15 A, 60 Hz

Technical Information

All product dimensions are nominal.

Installation:	Drop-in, Under-mount
Drain location:	End
Basin area, bottom:	44-1/2" x 26-1/2" (1130 mm x 673 mm)
Basin area, top:	60-1/4" x 30-1/4" (1530 mm x 768 mm)
Weight:	86 lbs (39 kg)
Minimum floor load:	58 lbs/ft ² (283.2 kg/m ²)
Water depth:	17-3/4" (451 mm)
Water capacity:	102 gal (386.1 L)
Cutout:	Drop-in, 65" x 35" (1651 mm x 889 mm)
Electrical component rating:	Heated Surface: 120 V, 0.5 A, 60 Hz, 65 W
Minimum flat for door:	2-7/16" (61 mm)

Notes

Measure your actual product for rough-in details. Install this product according to the installation instructions.

The hot water supply should be 70% of the capacity of the bath or greater. Installations will vary.

Kit is required for under-mount installations (sold separately).