



Bathtub - CL.1

WATER FALL Cascade spout for wall-mounted installation - polished chrome

Article number: 13 420 979-00

- 4-3/4" Projection
- Cascade
- Cover plate 9-1/2" x 2-3/8"
- 1/2" connection
- Plug-in connection mounting
- Water flow rate limited to max. 7 gpm
- Fittings group in compliance with DIN 4109: 2

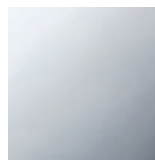

polished chrome

Accessory is required for this item.

Dimensional drawing

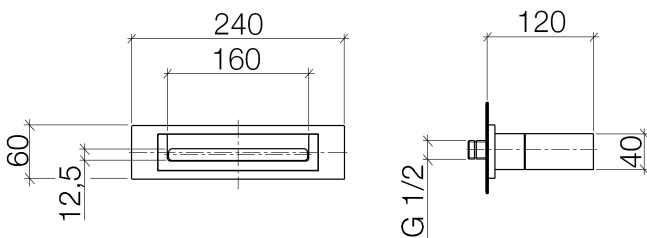

All dimensions in mm / inch = mm x 0,0394



Bathtub - CL.1

WATER FALL Cascade spout for wall-mounted installation - polished chrome

Article number: 13 420 979-00

Flow rate chart

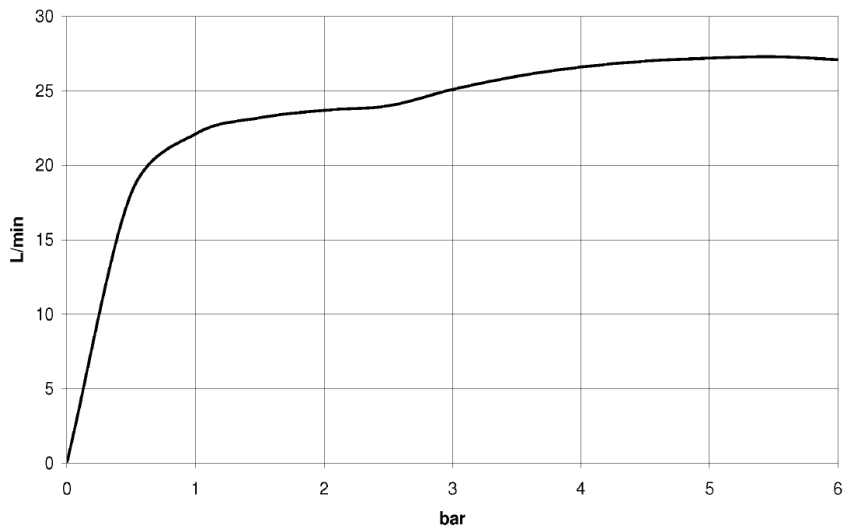

Trajectory length diagram

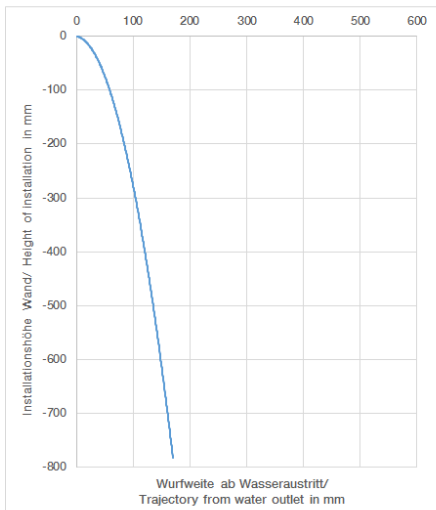



Bathtub - CL.1

WATER FALL Cascade spout for wall-mounted installation - polished chrome

Article number: 13 420 979-00

Other surface finishes



platinum matte
13 420 979-06



platinum
13 420 979-08

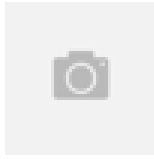

Brushed Durabrass
13 420 979-28

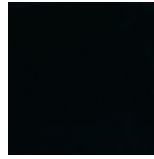

black matte
13 420 979-33

More custom finish options are available via special production (xTra Service). Please see our finish matrix for availability and pricing or contact a Dornbracht representative.

Required article



35 080 970-90 0010

Rough-in adapter -

Bathtub - CL.1

WATER FALL Cascade spout for wall-mounted installation - polished chrome

Article number: 13 420 979-00

Spare parts list

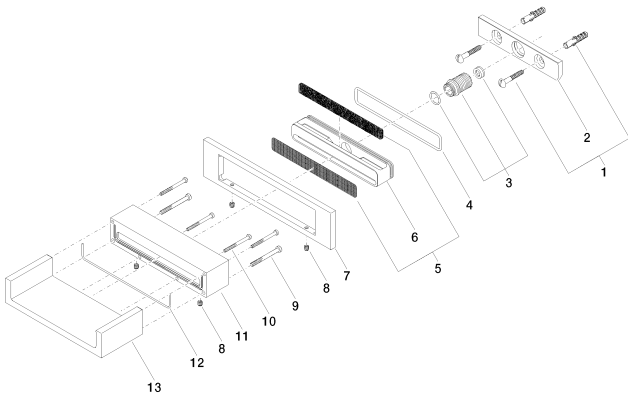

Number	Item Number	Designation	Number of units
1	04 30 31 024 01 90	fixing set	1
2	09 17 97 056 90	holder	1
3	90 24 05 008 00 90	nipple set	1
4	09 14 10 504 90	seal	1
5	90 29 30 040 00 90	insert	1
6	09 17 11 044 20 90	distributor	1
7	09 27 97 034-00	rosette	1
8	09 31 11 049 90	pin	4
9	09 30 30 147 90	screw	2
10	09 30 30 086 90	screw	4
11	09 30 01 104-00	casing	1
12	09 14 03 504 90	seal	1
13	09 11 94 046-00	spout	1