

CRYSTORAMA

LIGHTING THE WAY FOR SIXTY YEARS
ASSEMBLY INSTRUCTION MODEL #PAY-921-BF

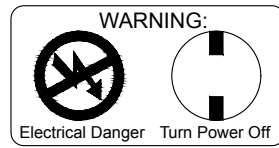

All electrical components must be installed by a licensed electrician in accordance with the National Electric Code and the appropriate local electrical codes.

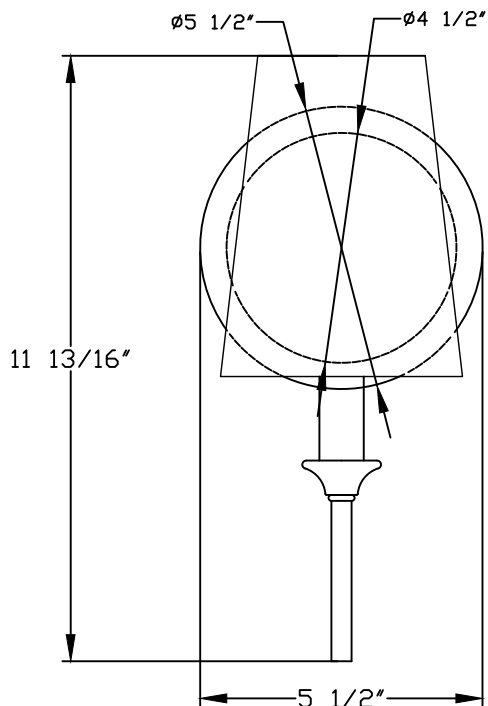
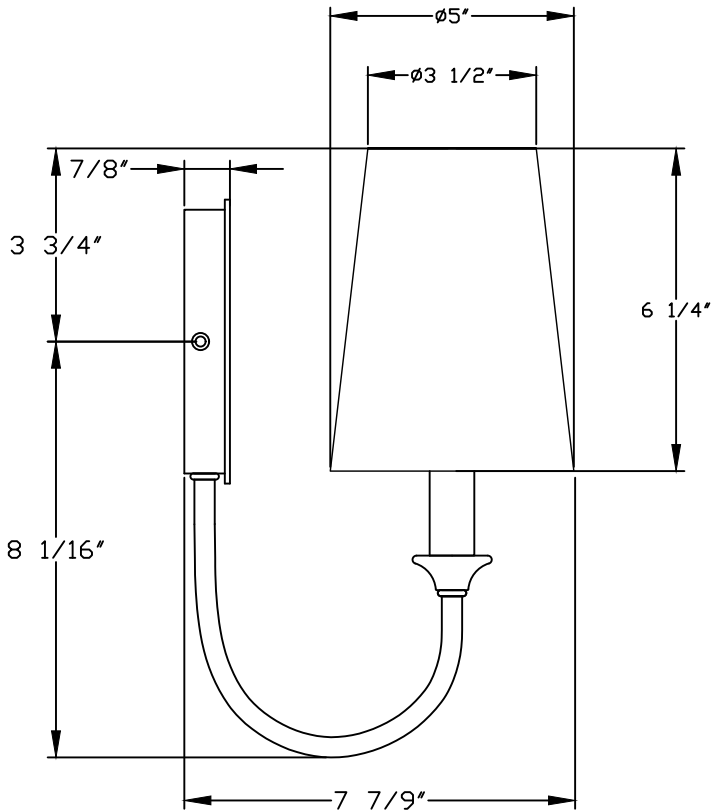

You will need 1-Candelabra Base Bulb
40Watts Recommended 60 Watts Max.

USE LED BULBS FOR EXTENDED USE

The fixture is damp rated

How to Install

1. Install the mounting plate onto the outlet box using two outlet box screws
2. Attach the backplate onto the mounting plate and secure with screws.
3. Slide the candle sleeve over the socket. Slide the shade over the candle sleeve.

⚠ WARNING: This product can expose you to lead which is known to the State of California to cause cancer and/or birth defects or reproductive harm. For more information go to www.P65Warnings.ca.gov

CRYSTORAMA

LIGHTING THE WAY FOR SIXTY YEARS
ASSEMBLY INSTRUCTION MODEL #PAY-921-BF

Part Number

Part Numbers

- A. (1)-Mounting plate
- B. (2)-Outlet Box Screws
- C. (3)-Wire Connector
- D. (2)-Screw
- E. (1)-Backplate(W5.5"xH7/8") XEH921BFBKP5.5IN
- F. (1)-Metal Sleeve(Ø7/8"xH3.3") XEH921BFCDL3.3IN
- G. (1)-Fabric Shade(W5"xH6.25") XEH921SHA6.25IN

