

CRYSTORAMA

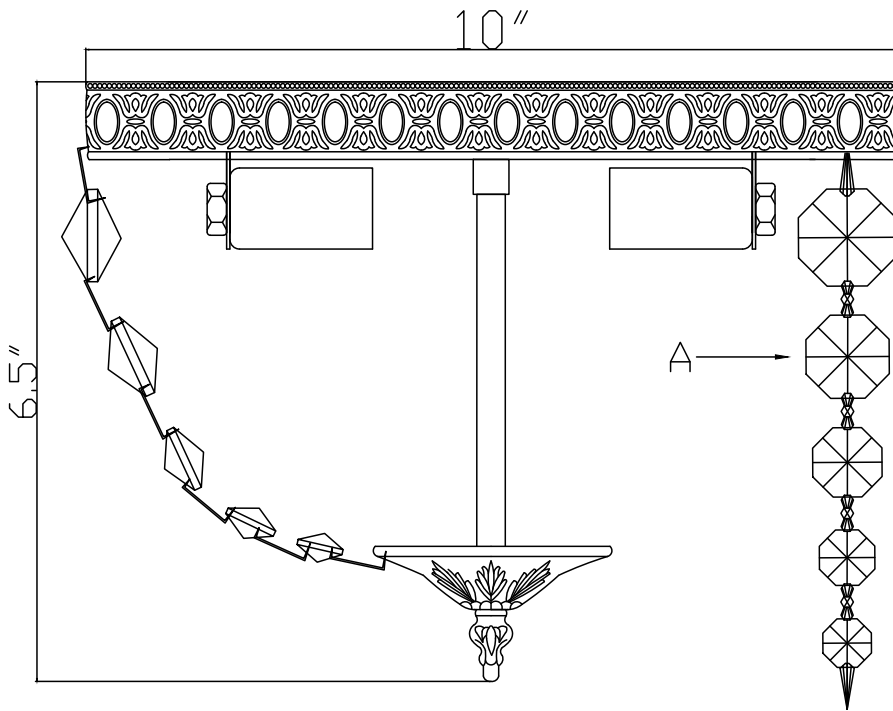

LIGHTING THE WAY FOR SIXTY YEARS

ASSEMBLY INSTRUCTION MODEL #710-EB-CL-SAQ



WARNING:



Electrical Danger



Turn Power Off

All electrical components must be installed by a licensed electrician in accordance with the National Electric Code and the appropriate local electrical codes.

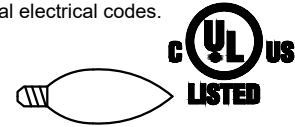

You will need 2-Candelabra Base Bulb
40 Watts recommended 60 Watts Max.
USE LED BULBS FOR EXTENDED USE

The fixture is Dry rated

HOW TO INSTALL:

Place the fixture parts on a soft cloth-covered platform before installation of fixture.

1. Install the mounting bar onto the outlet box.
2. Raise the Frame up over the threaded nipple on the mounting bar.
After the wire connection is completed, Secure with the coupling.
3. Screw the center stem onto the coupling and secure with the nut.
4. Adjust the hex nut along the bottom end of the center stem to allow the vase cap to stay in the correct position.
Secure the cap with the finial.
5. Dress the crystals as illustrated.

Crystal Sets

- A. 25Sets. (1)28mm + (1)26mm +
(1)20mm + (1)16mm + (1)14mm

WARNING: This product can expose you to Lead, which is known to the State of California to cause cancer and/or birth defects or reproductive harm. For more information go to www.p65warnings.ca.gov

CRYSTORAMA



LIGHTING THE WAY FOR SIXTY YEARS

ASSEMBLY INSTRUCTION MODEL #710-EB-CL-SAQ

Part Number

Part Numbers

- A. (2)-Wire Connector
- B. (1)-Mounting bar
- C. (2)-Screw
- D. (1)-Hex nut
- E. (1)-Threaded nipple
- F. (1)-Frame ; $\text{\O}10''$; 25 pin holes ; with inner plate.
- G. (1)-Coupling
- H. (2)-Hex Nut
- I. (2)-Socket
- J. (1)-Center stem ; H 4 1/2"-XSN708EBSTEM4.5IN
- K. (1)-Vase Cap ; $\text{\O}3''$; 25 pin holes-XSN710EBCAP3IN
- L. (1)-Finial-XSN708EBFIN

