

MELROSE 275-44 INSTALLATION INSTRUCTIONS



GENERAL

1. To insure the success this fixture installation, the following instructions and diagram(s) should be read and understood. All electrical connections must be made in accordance with the National Electric Code and local codes and ordinances. If you are uncertain of the methods of installing electrical wiring and lighting fixtures, secure the services of a qualified licensed electrician.
2. **TOOLS NEEDED:** Flat-blade screwdriver, adjustable wrench or slip-joint pliers, wire cutter/stripper, electrical current tester, stepladder and electrical tape.
NOTE: The important safeguards and instructions outlined on this sheet cannot cover all possible conditions and situations that may occur. It must be understood that common sense, caution and care are factors that cannot be built into any product. Caution and care must be supplied by the person(s) installing, operating and caring for this lighting fixture.

INSTALLATION PREPARATION

1. **TURN OFF THE ENTIRE ELECTRICAL CIRCUIT TO WHICH THE LIGHTING FIXTURE IS TO BE ATTACHED.**
Move the appropriate circuit breaker to the "off" position or completely remove the fuse controlling the circuit.
2. If an existing fixture is being replaced, remove it and note to which of the wires in the outlet box the fixture was attached. **DO NOT SEPARATE ANY OTHER WIRES THAT MAY BE IN THE BOX. DO NOT DAMAGE THE INSULATION OF OLDER WIRING.** In regular circumstances the BLACK wire will be the "Hot" lead and the WHITE wire will be the "Neutral" or "Common" lead. A GREEN or BARE COPPER wire is the "Ground". In older buildings it is always good practice to reconfirm the polarity of the wiring.
3. This fixture is designed to be mounted on a correctly installed, standard round or octagon box or a through wiring box with a plaster frame. The box must be securely mounted to the structure of the building.
4. **Carefully** Unpack the fixture, shade and parts bag. Before discarding the carton make sure that all parts are found.

FIXTURE INSTALLATION

1. Attach the crossbar to the outlet box (The green screw should face the floor).
2. Thread the 1/4 IP hex nut and lock washer onto the 1/4 IP nipple and the nipple into the crossbar. Tighten the hex nut against the crossbar.
3. Push the lead wires and ground wire (first) up through the 12.750" and 6.000" stems and connect both stems to the top of the light cluster.
4. Install the lamps (light bulbs).
NOTE: This fixture is rated for 60 W type B, BA, C or CA lamps.
DO NOT EXCEED RECOMMENDED WATTAGE!
5. Put one glass on top of the light cluster followed by glass holder, glass cover, and slip ring. Fasten slip ring using a set screw provided. Do not apply too much pressure on the glass.
6. Extend the stem length by adding (1x) 18" and (2x) 12" stems. Connect them to the 6" stem and hang straight with 1/8 IP nipples. Place the canopy over the hang straight.
7. Measure 6" of lead wire beyond the end of the stem. Cut off excess wire. Strip the insulation off the ends of the leads exposing approx. 1/2" of wire. Twist the strands of wire together. Push the leads and ground wire up through the stems, hang straight, canopy and into the outlet box.
8. Fasten the bare ground wire to the green or bare copper wire in the outlet box or the green screw on the crossbar.
NEVER FASTEN THE GROUND WIRE TO THE BLACK OR "HOT" WIRE!
FAILURE TO FOLLOW THIS INSTRUCTION COULD RESULT IN SERIOUS INJURY OR DEATH!
9. Fasten the fixture lead with the ridge(s) to the white wire in the outlet box. Fasten the wires together with an approved fastener (wire nut) Starting about 1" below the fastener, tightly wrap the connection with electrical tape so that the tape seals the end of the fastener.
Make sure that there is no exposed wire or strands that could cause a dangerous short circuit !

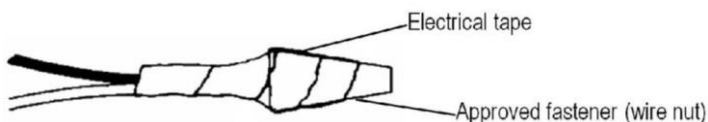
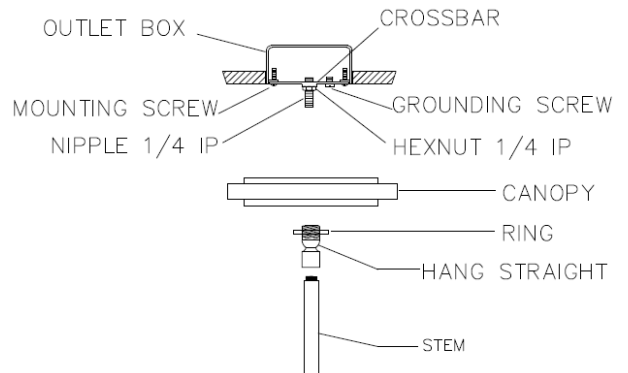

10. Connect the smooth fixture lead to the black wire in the outlet box.
Fasten the joined wires as in step 9.
11. Raise the fixture up and fully thread the hang straight to the nipple on the crossbar to secure the canopy to the ceiling.
12. Connect 11.750" stem to the bottom of the light cluster and install a 1/8 IP nipple to the bottom of the stem.
13. Install bottom glass, glass holder, glass cover and secure them by fastening a flat cap to the bottom stem.
14. Restore power circuit at breaker or fuse box.

