

Model No :: **62530LEDD-BS/OPL**
 Name :: Aqua



Project Name :: _____
 Location :: _____
 Type :: _____
 Quantity :: _____
 Notes :: _____

Product Information

Product ID :: 62530
 UPC Code :: 641594234794
 Mounting Type :: Wall
 Finish :: Brushed Steel (BS)
 Diffuser :: Opal (OPL)
 Alt. Finishes :: Brushed Gold (BG); Brushed Steel (BS)
 Alt. Diffusers :: Opal (OPL)

Product Dimensions

Fixture	Canopy
Length :: N/A	Length :: N/A
Width :: 19.25"	Width :: N/A
Diameter :: N/A	Diameter :: 4.5"
Extension :: 3.25"	Height :: N/A
Height :: 4.5"	
Overall Height :: N/A	



Technical Specifications

Qualifications

Location Rating :: Damp
 Certification :: ETL Listed (US/Canada)
 IES File ::
 JA8 Compliant :: Yes
 Energy Star :: No
 ADA Compliant :: Yes
 Marine Grade :: No
 Emergency Lighting :: No
 Warranty :: 5 Year Limited

Specifications

Frame Material :: Steel
 Diffuser Material :: Glass
 Voltage :: 120v
 Lamping Type :: Dedicated LED
 Lamping Base :: SSL
 Lamp Quantity :: 1
 Lamp Wattage :: 16 W
 Total Wattage :: 16w
 Lamps Included :: Yes
 J-Box Type :: Standard

Photometrics

CCT :: 3000
 CRI :: 90
 Wattage :: 16w
 Nominal Lumens :: 1280Lm
 Delivered Lumens :: 1034Lm

Recommended Dimmers

0

Additional Items :: 0

Line Drawing #1

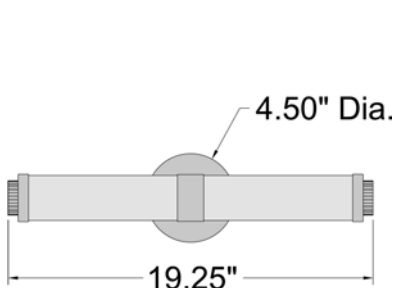

Line Drawing #2

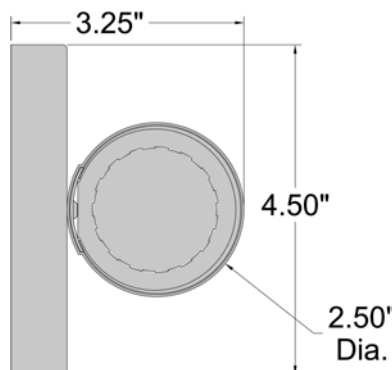

IES File

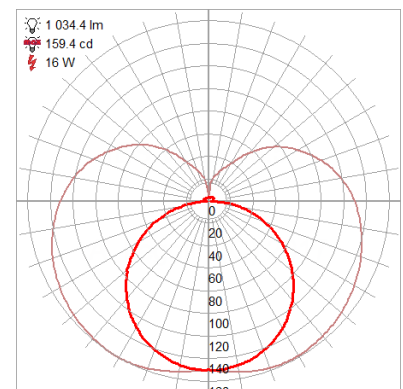

Toll Free 800-828-5483 • www.AccessLighting.com

14410 Myford Road, Irvine, CA 92606

The information provided is subject to change without notice. ©2020 Access Lighting Corporation. All Rights Reserved
 Rev. 202004 Filename:: 62530LEDD-BS_OPL.pdf

